



DOGE CT3

LA SIRENA-CENTRALE
THE SOUNDER-CONTROL PANEL

DOGE CT3



Un prodotto estremamente facile da installare, ideale per piccole installazioni come camper, garage, ponteggi e cantine.

DOGE CT3 is easy to install and particularly recommended for small applications like mini-flats, campers, garages, scaffolding and cellars.

3 zone bilanciate espandibili / 3 balanced extensible zones

1 parzializzazione / 1 partialization

Alimentatore 230 Vca / 230 Vac power supply

Lampeggiante a LED / LED flashing unit

2 suoni programmabili / 2 programmable sounds

Tempo di ingresso/uscita programmabile

Possibility to set entry/exit timing

Comandabile tramite telecomando e/o tastiera wireless

Manageable through remote control and wireless keypad

Uscita per combinatore telefonico GSM

Output for GSM phone dialer

ESEMPIO DI INSTALLAZIONE INSTALLATION EXAMPLE

IDEALE PER PROTEGGERE GARAGE IDEAL FOR PROTECTING GARAGE

MC 110
Contatto magnetico
Magnetic contact

FARO DT-AM PLUS
Sensore da interno
Indoor detector

MC 32P
Contatto magnetico per
basculanti
Magnetic contact for
overhead doors

MC 150
Contatto magnetico
per porta blindata
Magnetic contact for
armoured door

FARO IP PLUS
Sensore da esterno
Outdoor detector

DOGE CT3
Sirena/centrale
Sounder/control
panel

**INSTALLAZIONE E MANUTENZIONE FACILITATA
EASY INSTALLATION AND MAINTENANCE**

COLORI COLOURS

Coperchio Esterno
External cover

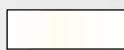

Bianco perlato
Pearly white

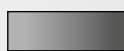

Acciaio
Grey



Champagne
Champagne

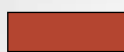

Rosso mattone
Brick red



Bronzo
Bronze

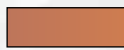

Rame
Copper



Cromo
Chromium
Colore disponibile con supplemento
Colour available at extra cost

Calotte
Flash covers

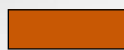

Arancio
Orange



Azzurro
Light blue



Fumè
Smoke grey

PERSONALIZZAZIONI CUSTOMIZATIONS

Supplemento per colore cromo
Extra cost for chromium version

Supplemento per colorazioni personalizzate (min. 50 pz.)
Extra cost for customized colours (100 pcs. min.)

Adesivi (min. 200 pz.) - Decalco (min. 50 pz.)
Embossed stickers (200 pcs. min.) - Decal (50 pcs. min.)

INSTALLAZIONE E MANUTENZIONE FACILITATA

EASY INSTALLATION AND MAINTENANCE

SIRENA/CENTRALE 3 ZONE 3-ZONE SOUNDER/ALARM CONTROL PANEL

Esempio di applicazione con radiocomando Vela o tastiera Onda Digital W e scheda di espansione / Application example with Vela remote control or Onda Digital W keypad and expansion board.

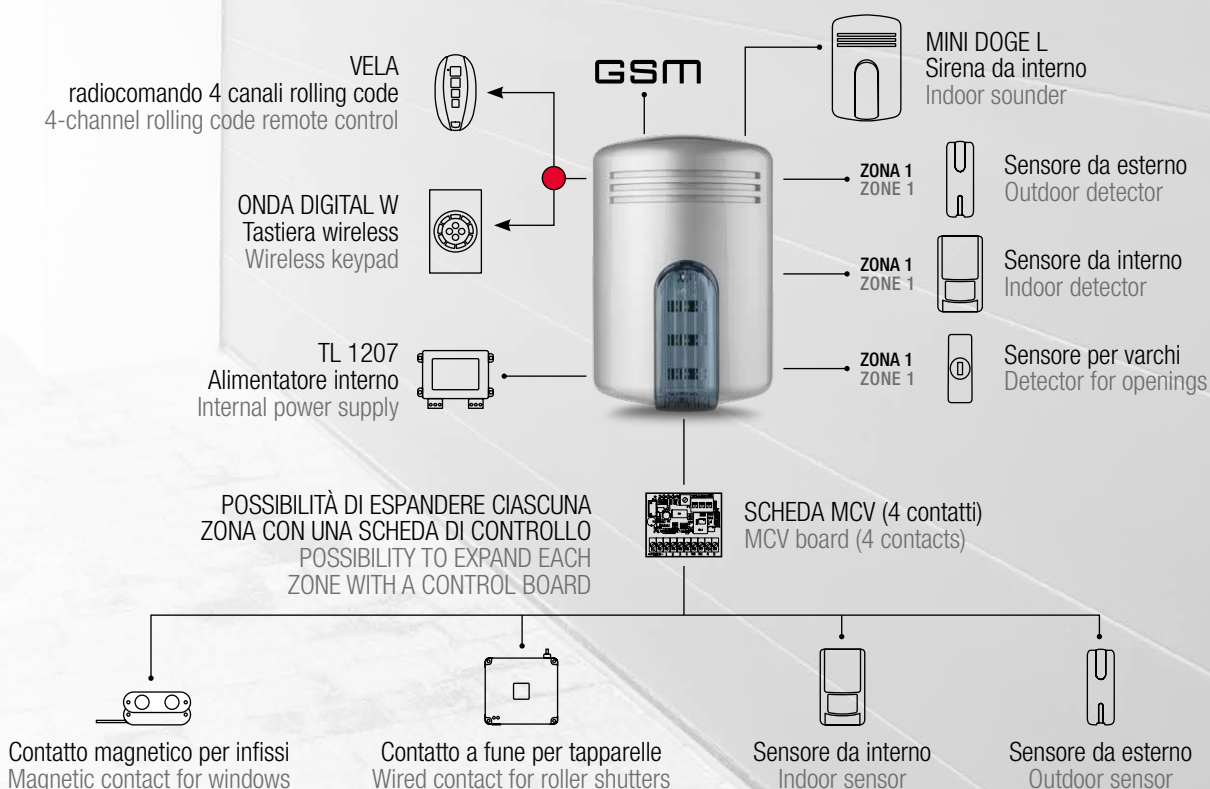

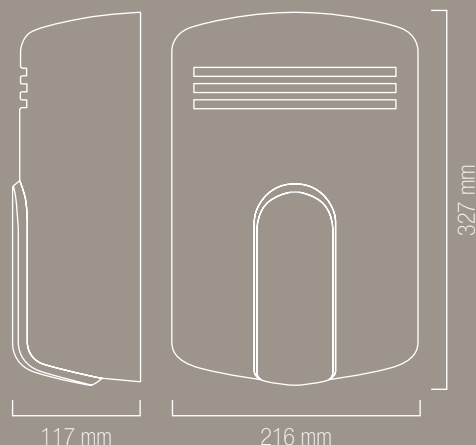

DATI TECNICI / TECHNICAL DATA

DOGE CT3

Alimentazione / Power supply	13.8 Vdc
Alimentatore interno TL 1207 (opzionale) / TL 1207 internal power supply (optional)	230 Vac
Attivabile anche tramite telecomando Vela e ricevente (non inclusi) It can be activated even by Vela Transmitter and receiver (not included)	•
Zone di allarme / Alarm zones	3
Ingresso attivazione per chiave elettronica o meccanica / Input for electronic or mechanical key	•
Zone ritardate per ingresso e uscita / Delayed zones for incoming and outgoing path	1
Visualizzazione a LED dell'accensione e spegnimento / Standby and Armed state signaled by LED	•
Memorizzazione e segnalazione della prima zona di allarme Memory and LED signaling of first zone alarm	•
Uscita per combinatore telefonico / Output for telephone dialer	1
Segnalazione mancanza rete / Mains failure notification	•
Autonomia 120 ore / Autonomy 120 hours	batteria Pb 12 V / 2.1 Ah Pb battery
Assorbimento a riposo / Standby absorption	7 mA
Assorbimento in allarme / Absorption in alarm	1.3 A suono/sound + 90 mA lampeggiante/flashing light
Sistema antiapertura e antirimozione a doppio tamper Anti-opening and anti-removal double-tamper system	•
Frequenza fondamentale / Main Frequency	1580 Hz / 1950 Hz (dipende dal suono it depends on the sound)
Pressione sonora: dB (A) a 3 mt / Sound level dB (A) a 3 mt	107 dB MAX
Lampeggiante a LED / LED flashing light	90 mA
Tamper doppio reed magnetico antiapertura ed antistrappo Double magnetic tamper reed anti-removal and anti-opening	•
Suoni programmabili / Programmable sounds	2
2 temporizzazioni / 2 timings	3' oppure/or 8'
Sistema antischiuma e antishock brevettato / Anti-foam and anti-shock patented system	•
Sistema antiperforazione / Drilling proof system	opzionale - optional
Batteria tampone / Buffer battery type	12 V 2.1 Ah Pb o/or 12 V 1.2 Ah Pb
Autodiagnosi di / Self-tests of:	Tromba, Microcontrollore Siren, microcontroller
Tipi di test batteria / Battery Tests	Connessione, carica, vecchiaia Plug, charge, old battery
Grado protezione / Protection level: IP 44	•
Temperatura di funzionamento / Operating temperature: -25°C ÷ +55°C	•
Certificazione di Conformità alla Normativa EN 50131-4 e EN 61000-6-3 Complying with EN 50131-4 and EN 61000-6-3 Standard	•
Peso (gr.) / Weight (gr.)	2370